



FLOORING SURFACES SPRINGSTEP IV

For Architects,
Specifiers and
General Contractors

Special Features

- Do-it-yourself in hours instead of days
- Transportable
- Includes the wood and shock absorption layer
- No hardware, screws, patching or sanding
- Snap together patented tongue and groove construction

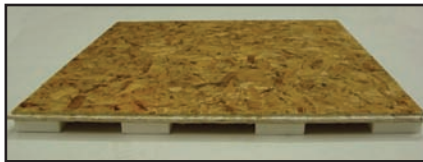

Springstep IV panel

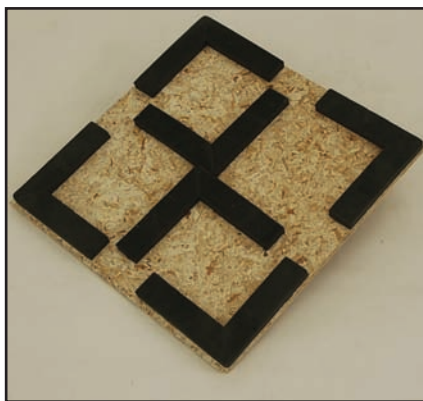

View from bottom of Springstep IV panel



"Eco-friendly" products meet one or more of the following criteria: recyclable, reusable, made from recycled post consumer materials, made from renewable sources, made from managed forests, packaged in recyclable containers, made from recoverable waste materials or have no VOC's.

The standard for floating wood resilient permanent and semi-permanent subfloors for concrete slabs and other hard surfaces. Resilient and energy absorbent. Safety and performance at a great price.

SPRINGSTEP IV

The easy subfloor. The nominal 2' x 2' pre-fabricated Random Wafer Board panels, with patented tongue and groove connection system, rest on "L" shaped high density foam suspension forms. Springstep IV offers excellent energy absorption and resilience. Panels are sealed for water resistance. Its tongue and groove system allows for easy assembly.

The lightweight, 6.5 lb panels can be installed in hours instead of days. No screws. No staples. No nails. No patching. No sanding. It is 1/3 the work with no tools required.*

Easy to disassemble, move to a new location and re-install.

* Circular saw may be needed for custom fit.

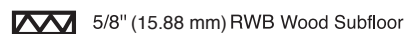
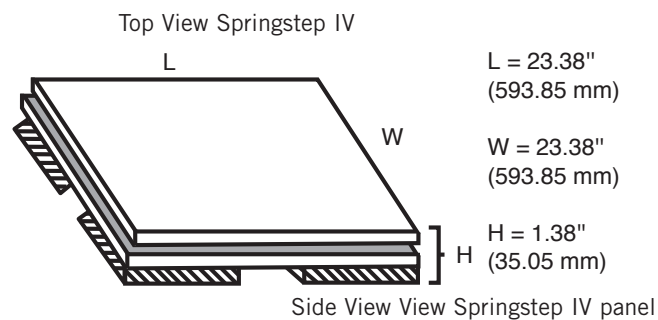

OVERALL HEIGHT 1.38 inches (35.05 mm)

STAGESTEP

Flooring Systems for Dance, Theatre and the Performing Arts.

aeson
FLOORING SYSTEMS

Leading The Way In Health & Fitness Flooring

800-523-0960 (Toll free in U.S. & Canada)
215-636-9000

www.stagestep.com • www.aesonflooring.com



FLOORING SURFACES SPRINGSTEP IV

	WOOD PANEL SIZE	UNDERLAYMENT
SPRINGSTEP IV	23.38" x 23.38" x 5/8" (593.85 mm x 593.85 mm x 15.88 mm) wood panels	3/4" (19.05 mm) thick "L" shaped foam forms
SPRINGSTEP IV-A	23.38" x 23.38" x 5/8" (593.85 mm x 593.85 mm x 15.88 mm) wood panels	1/2" (12.70 mm) foam sheeting
SPRINGSTEP IV-B	23.38" x 23.38" x 5/8" (593.85 mm x 593.85 mm x 15.88 mm) wood panels	2" x 2" x 2" (50.80 mm x 50.80 mm x 50.80 mm) foam cubes
SPRINGSTEP IV-C	23.38" x 23.38" x 5/8" (593.85 mm x 593.85 mm x 15.88 mm) wood panels	3" x 3" x 3/4" foam blocks (peel & stick)
SPRINGSTEP IV-P	23.38" x 23.38" x 5/8" (593.85 mm x 593.85 mm x 15.88 mm) wood panels	Available in any of the above configurations

INDIVIDUAL COMPONENTS

- 23.38" x 23.38" x 5/8"
(593.85 mm x 593.85 mm x 15.88 mm)
 - 3/4" (19.05 mm) thick "L" shaped foam forms
not sold separately
 - 1/2" (12.70 mm) foam sheeting (5' wide by your
custom length)
 - 2" x 2" x 2" (50.80 mm x 50.80 mm x 50.80 mm)
foam cube
 - 2" x 2" x 2" (50.80 mm x 50.80 mm x 50.80 mm)
Peel and Stick foam cube
 - 3" x 3" x 3/4" (thick) peel & stick foam blocks
- * Minimum order 500 blocks. Continental USA Only.

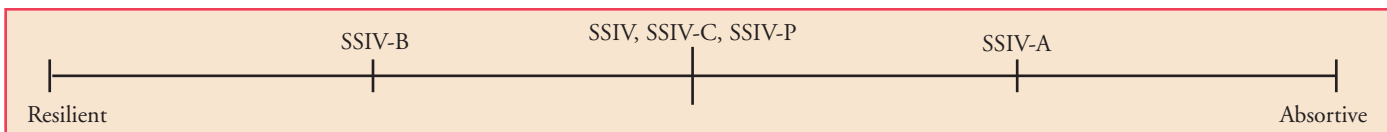
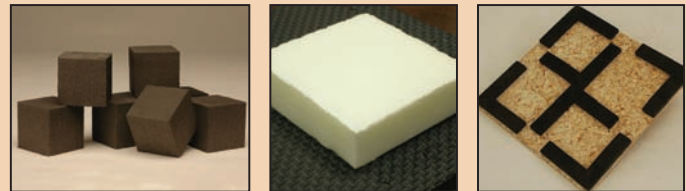

EDGING & TRANSITION PIECES

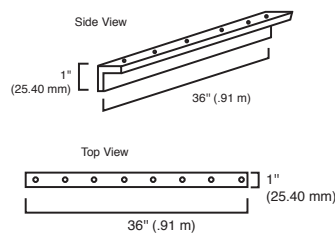

STRAIGHT EDGING

(1" wide x 1" high x 36" long)
(25.40 mm x 25.40 mm x .91 m)

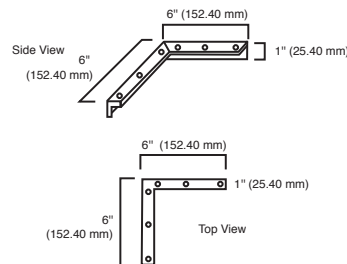

CORNER EDGING

(6" x 6" x 1" L shape)
(152.40 mm x 152.40 mm x 25.40 mm)

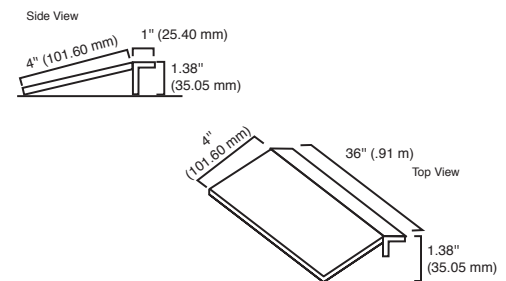

TRANSITION PIECE

(36" long x 1.38" high x 4" slope)
(.91 m x 35.05 mm x 101.60 mm)
Required for OSHA regulations.

STAGESTEP
Flooring Systems for Dance, Theatre and the Performing Arts.

aeson
FLOORING SYSTEMS
Leading The Way In Health & Fitness Flooring

800-523-0960 (Toll free in U.S. & Canada)
215-636-9000

www.stagestep.com • www.aesonflooring.com